

IEC Connector C13, Rewireable, Angled



IEC Appliance Outlet C13 for cable mounting
 Screw-on mounting
 angled



Example with assembled cable

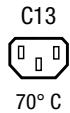

See below:
[Approvals and Compliances](#)

Description

- Cord Connectors (Rewireable) :
 Screw-on mounting
- 1 Function :

- Connector , Pin temperature 70 °C , Protection class I
- Cable

Weblinks

[pdf data sheet](#), [html datasheet](#), [General Product Information](#), [Approvals](#), [Distributor-Stock-Check](#), [Accessories](#), [Detailed request for product](#)

Technical Data

Ratings IEC	10A / 250VAC; 50Hz	Appliance inlet/-outlet	C13 acc. to IEC 60320-1
Ratings UL/CSA	15A / 125VAC; 60Hz		UL 498, CSA C22.2 no. 42 (for cold conditions) pin-temperature 70 °C, 10A, Protection Class I
	10A / 250 VAC; 60Hz		
Dielectric Strength	> 2 kVAC between L-N > 2 kVAC between L/N-PE (1 min/50Hz)		
Allowable Operation Temperature	-25 °C to 70 °C		
Protection against electric shock	Suitable for appliances with protection class I acc. to IEC 61140		
Terminal	Cable		
Material: Housing	Thermoplastic, black, UL 94V-2		

Approvals and Compliances

Detailed information on product approvals, code requirements, usage instructions and detailed test conditions can be looked up in [Details about Approvals](#)

SCHURTER products are designed for use in industrial environments. They have approvals from independent testing bodies according to national and international standards. Products with specific characteristics and requirements such as required in the automotive sector according to IATF 16949, medical technology according to ISO 13485 or in the aerospace industry can be offered exclusively with customer-specific, individual agreements by SCHURTER.

Approvals





The approval mark is used by the testing authorities to certify compliance with the safety requirements placed on electronic products.

Approval Reference Type: 4300-06

Approval Logo	Certificates	Certification Body	Description
	KEMA Approvals	KEMA	Certificate Number:
	UL Approvals	UL	UR File Number: E60148

Product standards

Product standards that are referenced

Organization	Design	Standard	Description
	Designed according to	IEC 60320-1	Appliance couplers for household and similar general purposes
	Designed according to	IEC 60320-1	Appliance couplers for household and similar general purposes
	Designed according to	UL 498	Standard for Attachment Plugs and Receptacles
	Designed according to	CSA C22.2 no. 42	General Use Receptacles, Attachment Plugs, and Similar Wiring Devices





Application standards

Application standards where the product can be used

Organization	Design	Standard	Description
	Suitable for applications acc.	IEC/UL 62368-1	Audio/video, information and communication technology equipment - Part 1: Safety requirements

Compliances

The product complies with following Guide Lines

Identification	Details	Initiator	Description
	CE declaration of conformity	SCHURTER AG	The CE marking declares that the product complies with the applicable requirements laid down in the harmonisation of Community legislation on its affixing in accordance with EU Regulation 765/2008.
	UKCA declaration of conformity	SCHURTER AG	The UKCA marking declares that the product complies with the applicable requirements laid down in the British Amendment of Regulation (EC) 765/2008.
	RoHS	SCHURTER AG	Directive RoHS 2011/65/EU, Amendment (EU) 2015/863
	China RoHS	SCHURTER AG	The law SJ / T 11363-2006 (China RoHS) has been in force since 1 March 2007. It is similar to the EU directive RoHS.
	REACH	SCHURTER AG	On 1 June 2007, Regulation (EC) No 1907/2006 on the Registration, Evaluation, Authorization and Restriction of Chemicals 1 (abbreviated as "REACH") entered into force.

Dimensions [mm]

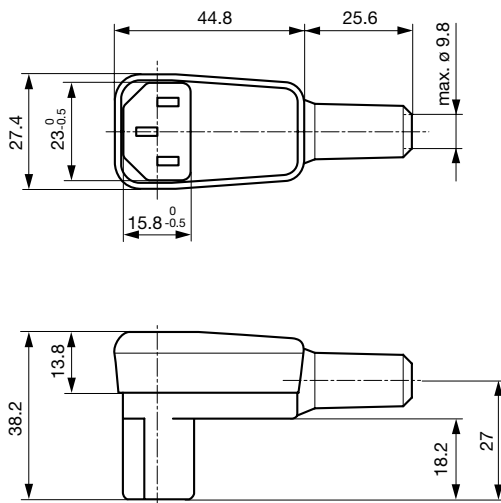

Variants

Color	Recommended cable diameter	Max. wire size	L = Length of cable guard	Order Number
black	8.5 mm	3 x 1 mm ² / 3 x 18 AWG	-	4300.0609

Availability for all products can be searched real-time: <https://www.schurter.com/en/info-center/support-tools/stock-check-distributors>

Max. torque for screws: Terminals: 0.6 Nm, Cable clamps: 0.3 Nm, Cover: 0.3 Nm

Packaging unit 45 Pcs

Mating Inlets/Plugs

Category / Description

» [Overview complete](#)



IEC Appliance Inlet C14 with Line Switch 1-pole	KEB1
IEC Appliance Inlet C14, with Line Switch 2-pole, Voltage Selector and Fuseholder 1or 2-pole	6766
IEC Appliance Inlet C14 with Line Switch 1- or 2-pole	6010-K
IEC Appliance Inlet C14 with Fuseholder 2-pole, Line Switch 2-pole and Voltage Selector	GRM1
IEC Appliance Inlet C14 with Appliance Outlet F, Line Switch 2-pole and Voltage Selector	PMM
...	

[Appliance Inlet Overview complete](#)



6061, Mounting: Screw, Appliance Inlet: IEC C14	6080
6100-3, Mounting: Screw, Solder / Quick Connect, Appliance Inlet: IEC C14	6100-3
6100-4, Mounting: Snap-in, Solder / Quick Connect, Appliance Inlet: IEC C14	6100-4
6102-3, Mounting: Screw, Solder / Quick Connect, Appliance Inlet: IEC C18	6102-3
6102-5, Mounting: Snap-in, Solder / Quick Connect, Appliance Inlet: IEC C18	6102-5
...	

[Distribution Unit Overview complete](#)



0712-PQ, Mounting: Snap-in, Front Side, Solder terminal (4.8 x 0.8 mm), 1x Appliance Outlet: IEC F	0712
4741, Mounting: 2x Appliance Outlet: IEC F	4741
4747, Mounting: 4x Appliance Outlet: IEC F	4747
4740, Mounting: 6x Appliance Outlet: IEC F	4740

[IEC Inlet Filter Overview complete](#)



GRF2, Mounting: Rear Side, With EMC-shield and without line filter, 10 A, Plug Connector, Appliance Inlet: IEC C14, Suitable for appliances with protection class I	GRF2
5110, Mounting: Screw, Front Side, Filter: Standard and Medical Version, Without fuse holder: 10 A, Thermoplastic Appliance Inlet: IEC C14, prewired, Suitable for appliances with protection class I	5110
KFS, Mounting: Screw, Front Side, Filter: Standard version, Without fuse holder: 10 A, Appliance Inlet: IEC C14, pre-wired	KFS

[Plug Overview complete](#)



4732, Mounting: Power Cord, Plug: IEC E, Cable	4732
4735, Mounting: Power Cord, Plug: IEC E, Cable	4735
9009, Mounting: Plug: IEC E, Screw clamps	9009
4733, Mounting: Power Cord, Plug: IEC E, Cable	4733
4736, Mounting: Power Cord, Plug: IEC E, Cable	4736
...	

Category / Description

Power Entry Module Overview complete



DF11, Mounting: Screw, Rocker switch: non-illuminated or illuminated 2-pole, Quick connect terminals 6.3 x 0.8 mm, Appliance Inlet: IEC C14, Without fuse holder: Suitable for appliances with protection class I or II 0 DF11, Mounting:Screw, Quick connect terminals 6.3 x 0.8 mm, Without fuse holder: Rocker switch, non-illuminated or illuminated, 2-pole, Appliance Inlet: IEC C14, 250 VAC, prewired, Suitable for appliances with protection class I or II 0 DF11, Power Entry Module C14, 55°C, version: L: N: ground: : fuseholder: color: design: dimension S: features: 0 DF11, Mounting: Snap-in/screw-on, Appliance Inlet: IEC C14, Without fuse holder: : black, Suitable for appliances with protection class I or II 0 DF11, Mounting: Snap-in/screw-on 8 mm, Quick connect terminals 6.3 x 0.8 mm, IP40,: black, Appliance Inlet: IEC C14, Circuit Breakers TA45, A, non-illuminated, Protection Class I or II 0 DF11, Mounting: Snap-in/screw-on, mm, Without fuse holder: : IEC Suitable for appliances with protection class I or II 0	DF11
DD11, Mounting: Screw-on mounting, Rocker switch: non-illuminated or illuminated 2-pole, Quick connect terminals 4.8 x 0.8 mm, Appliance Inlet: IEC C14, With or without protection cover, Fuseholder: 1-/2-pole, Suitable for appliances with protection class I	DD11
DD21, Mounting: Screw-on mounting Rear Side, Rocker switch: non-illuminated or illuminated 2-pole, additional quick connect 4.8 x 0.8 mm Appliance Inlet: IEC C14, Fuseholder: 1-/2-pole	DD21
DC11, Mounting: Screw, Rocker switch: non-illuminated or illuminated 1-/2-pole, Quick connect terminals 4.8 x 0.8 mm, Appliance Inlet: IEC C14, Without fuse holder: Suitable for appliances with protection class I or II	DC11
KEB2, Mounting:Screw, Quick connect terminals 4.8 x 0.8 mm, Without fuse holder: Rocker switch, non-illuminated or illuminated, 2-pole, Appliance Inlet: IEC C14, 250 VAC, prewired, Suitable for appliances with protection class I	KEB2
...	...

Power Entry Module with line filter Overview complete



DG12, Mounting : Screw, 8 mm, 15 A, prewired, Standard and Medical Version, Appliance Inlet: IEC C14 C18, Circuit Breakers TA35: DG12, Suitable for appliances with protection class I or II	DG12
DD14, Mounting: Screw-on mounting, Front Side, Filter, Standard and Medical Version, Fuseholder:1-/2-pole, 10 A, Rocker switch: 2-pole, non-illuminated Appliance Inlet: IEC C14, prewired	DD14
DD12, Mounting: Screw-on mounting, Front Side, Filter, Standard and Medical Version, Fuseholder:1-/2-pole, 10 A, Rocker switch: 2-pole, non-illuminated Appliance Inlet: IEC C14, prewired	DD12
KFB2, Mounting: Screw, Front Side, Filter: Standard and Medical Version, Without fuse holder: 10 A, Rocker switch: 2-pole, Appliance Inlet: IEC C14, prewired	KFB2
DC12, Mounting: Screw, Front-/Rear-Side, Filter, Standard and Medical Version, Without fuse holder:10 A, Rocker switch: 1-/2-pole, non-illuminated or illuminated Appliance Inlet: IEC C14, prewired	DC12
...	...