

IEC Appliance Outlet F or H, Screw-on Mounting, Front Side, Solder or Quick-connect Terminal

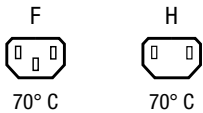

See below:

Approvals and Compliances

Description

- Panel mount :
Screw-on mounting , front side
- 1 Function :
- Connector , Pin temperature 70 °C , protection class I or II
- Solder / Quick Connect

References

We recommend for new applications the type [6600-3](#)

Weblinks

[pdf data sheet](#), [html datasheet](#), [General Product Information](#), [Approvals](#), [Distributor-Stock-Check](#), [Accessories](#), [Detailed request for product](#)

Technical Data

Ratings IEC	10A / 250VAC; 50Hz
Ratings UL/CSA	15A / 250VAC; 60Hz
Dielectric Strength	> 4 kVAC between L-N
	> 2 kVAC between L/N-PE (1 min/50Hz)
Allowable Operation Temperature	-25 °C to 70 °C
IP-Protection	front side IP20 acc. to IEC 60529
Protection against electric shock	Suitable for appliances with protection class I or II acc. to IEC 61140
Terminal	Solder / Quick Connect
Material: Housing	PA6, black or grey, UL 94V-0

Appliance inlet/-outlet	F acc. to IEC 60320-3 / H UL 498, CSA C22.2 no. 42 (for cold conditions) pin-temperature 70 °C, 10A, Protection Class I or II
-------------------------	--

Approvals and Compliances

Detailed information on product approvals, code requirements, usage instructions and detailed test conditions can be looked up in [Details about Approvals](#)

SCHURTER products are designed for use in industrial environments. They have approvals from independent testing bodies according to national and international standards. Products with specific characteristics and requirements such as required in the automotive sector according to IATF 16949, medical technology according to ISO 13485 or in the aerospace industry can be offered exclusively with customer-specific, individual agreements by SCHURTER.

Approvals





The approval mark is used by the testing authorities to certify compliance with the safety requirements placed on electronic products.

Approval Reference Type: 5098

Approval Logo	Certificates	Certification Body	Description
	VDE Approvals	VDE	VDE Certificate Number: 40010295
	UL Approvals	UL	UR File Number: E57445
	CSA Approvals	CSA	CSA Certification Record: 27324

Product standards

Product standards that are referenced

Organization	Design	Standard	Description
	Designed according to	IEC 60320-1	Appliance couplers for household and similar general purposes
	Designed according to	H	Direct current (DC) appliance couplers for information and communication technology (ICT) equipment installed in data centers and telecom central offices - Part 3: AC/DC appliance inlet
	Designed according to	IEC 60320-3	Appliance couplers for household and similar general purposes
	Designed according to	UL 498	Standard for Attachment Plugs and Receptacles
	Designed according to	CSA C22.2 no. 42	General Use Receptacles, Attachment Plugs, and Similar Wiring Devices





Application standards

Application standards where the product can be used

Organization	Design	Standard	Description
	Suitable for applications acc.	IEC/UL 62368-1	Audio/video, information and communication technology equipment - Part 1: Safety requirements

Compliances

The product complies with following Guide Lines

Identification	Details	Initiator	Description
	CE declaration of conformity	SCHURTER AG	The CE marking declares that the product complies with the applicable requirements laid down in the harmonisation of Community legislation on its affixing in accordance with EU Regulation 765/2008.
	UKCA declaration of conformity	SCHURTER AG	The UKCA marking declares that the product complies with the applicable requirements laid down in the British Amendment of Regulation (EC) 765/2008.
	RoHS	SCHURTER AG	Directive RoHS 2011/65/EU, Amendment (EU) 2015/863
	China RoHS	SCHURTER AG	The law SJ / T 11363-2006 (China RoHS) has been in force since 1 March 2007. It is similar to the EU directive RoHS.
	REACH	SCHURTER AG	On 1 June 2007, Regulation (EC) No 1907/2006 on the Registration, Evaluation, Authorization and Restriction of Chemicals 1 (abbreviated as "REACH") entered into force.

Dimensions [mm]

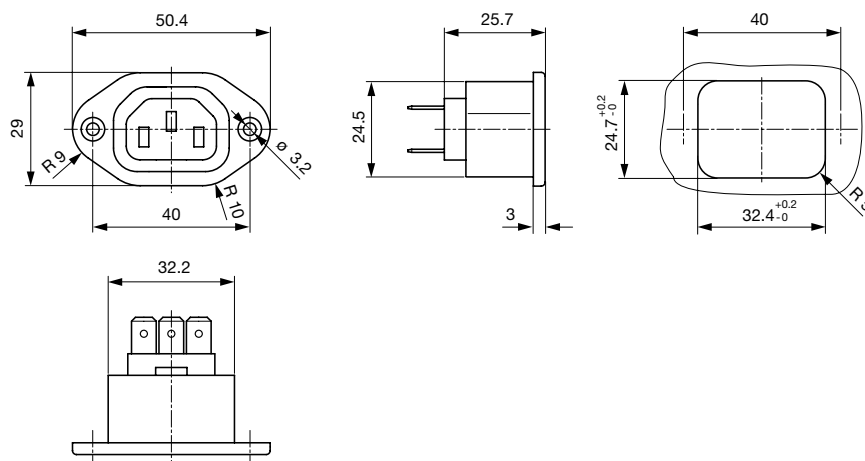

Length of the terminal please find at the order code configuration table

Config. Code



5098 - H - A B C 0 - D - E

The characters are placeholders for the correspondingly keys of selections from the key tables.

5098 - **H** - A B C 0 - D - E = Type

Type	Configuration key
protection class II	B
protection class I	X

5098 - H - A B C 0 - D - E = Terminals

Terminal L	Configuration key
solder terminal 	1
PCB-terminal standard 	4
Blade terminal (6.3 x 0.8 mm) 	9

5098 - H - A B C 0 - D - E = Terminals

Terminal N	Configuration key
solder terminal	1
PCB-terminal standard	4
Blade terminal (6.3 x 0.8 mm)	9

Symbols similar as in table A

5098 - H - A B C 0 - D - E = Terminals

Terminal Ground	Configuration key
without terminal	0
solder terminal	1
PCB-terminal standard	4
Blade terminal (6.3 x 0.8 mm)	9

Symbols similar as in table A

5098 - H - A B C 0 - D - E = Color

Color	Configuration key
Black	A
Grey	B

5098 - H - A B C 0 - D - E = Style

Style	Configuration key
flange with countersunk holes	1
flange with through holes	2

Variants

Type	Terminals L / N	Terminal Ground	Color	Style	Features	Config. Code	Order Number
Protection class II	Quick connect terminal (6.3 x 0.8 mm)		black	Flange with countersunk holes	-	5098-B-9900-A-1	6182.0027
Protection class I	solder terminal	solder terminal	black	Flange with countersunk holes	-	5098-X-1110-A-1	6182.0028
Protection class I	Quick connect terminal (6.3 x 0.8 mm)	Quick connect terminal (6.3 x 0.8 mm)	black	Flange with countersunk holes	-	5098-X-9990-A-1	6182.0031

The listed variants should be available from stock. Other versions on request www.schurter.com/contact

Availability for all products can be searched real-time: <https://www.schurter.com/en/info-center/support-tools/stock-check-distributors>

Packaging unit 50 Pcs

Accessories

Description



RC320
 Rear Cover for Power Entry Module

Mating Inlets/Plugs

Category / Description

[Plug Overview complete](#)

4732, Mounting: Power Cord, Plug: IEC E, Cable	4732
4735, Mounting: Power Cord, Plug: IEC E, Cable	4735
9009, Mounting: Plug: IEC E, Screw clamps	9009
4733, Mounting: Power Cord, Plug: IEC E, Cable	4733
4736, Mounting: Power Cord, Plug: IEC E, Cable	4736
	...