

IEC Appliance Inlet C14 or C18 with Line Switch 1- or 2-pole



Screw-on mounting
Non-illuminated
from front side



Snap-in version
Non-illuminated



Screw-on mounting and line Switch illuminated
green



See below:
[Approvals and Compliances](#)

Description

- Panel mount :
Screw-on version from front or rear side, snap-in version front side
- Appliance Inlet protection class I or II , Line Switch 1- or 2-pole
- V-Lock notch standard
- Quick connect terminals 4.8 x 0.8 mm

Unique Selling Proposition

- Ultra compact design
- Line switch for high inrush currents
- Components internally wired
- V-Lock cord retaining

Characteristics

- All single elements are already wired
- Unwired versions available on request
- Line switch non-illuminated or illuminated
- Ideal for application with high transient loads
- Suitable for use in equipment according to IEC/UL 62368-1

Other versions on request

- Unwired versions
- Solder terminals
- Line switch with other rocker marking

References

Alternative: version with line filter [DC12](#)
 Substitute for type [6010-K](#); [KEB1](#); [KEB2](#)

Weblinks

[pdf data sheet](#), [html datasheet](#), [General Product Information](#), [Approvals](#), [Distributor-Stock-Check](#), [Accessories](#), [Detailed request for product](#)

Technical Data

Ratings IEC	10A / 250VAC; 50Hz	Appliance inlet/-outlet	C14 / C18 acc. to IEC 60320-1, UL 60320-1, CSA C22.2 no. 60320-1 (for cold conditions) pin-temperature 70 °C, 10A, Protection Class I or II
Ratings UL/CSA	15A / 250VAC; 60Hz	Line Switch	Rocker switch 1-/2-pole, non-illuminated or illuminated, acc. to IEC 61058-1 Technical Details
Dielectric Strength	> 2.5 kVAC between L-N > 3 kVAC between L/N-PE (1 min/50Hz)		
Allowable Operation Temperature	-25 °C to 70 °C		
IP-Protection	front side IP40 acc. to IEC 60529		
Protection against electric shock	Suitable for appliances with protection class I or II acc. to IEC 61140		
Terminal	Quick connect terminals 4.8 x 0.8 mm		
Panel Thickness S	Screw: max 6 mm Mounting screw torque max 0.5Nm Snap-in: 1/1.5/2/2.5/3 mm		
Material: Housing	Thermoplastic, black, UL 94V-0		

Approvals and Compliances



Detailed information on product approvals, code requirements, usage instructions and detailed test conditions can be looked up in [Details about Approvals](#)

SCHURTER products are designed for use in industrial environments. They have approvals from independent testing bodies according to national and international standards. Products with specific characteristics and requirements such as required in the automotive sector according to IATF 16949, medical technology according to ISO 13485 or in the aerospace industry can be offered exclusively with customer-specific, individual agreements by SCHURTER.

Approvals





The approval mark is used by the testing authorities to certify compliance with the safety requirements placed on electronic products.

Approval Reference Type: DC11

Approval Logo	Certificates	Certification Body	Description
	VDE Approvals	VDE	Certificate Number: 40007009
	UL Approvals	UL	UR File Number: E96454
	CCC Approvals	CCC	CCC Certificate Number: 2013010204594013



Product standards

Product standards that are referenced

Organization	Design	Standard	Description
	Designed according to	IEC 60320-1	Appliance couplers for household and similar general purposes
	Designed according to	IEC 61058-1	Switches for appliances. Part 1. General requirements
	Designed according to	UL 60320-1	Standard for Attachment Plugs and Receptacles
	Designed according to	CSA C22.2 no. 60320-1	General Use Receptacles, Attachment Plugs, and Similar Wiring Devices







Application standards

Application standards where the product can be used

Organization	Design	Standard	Description
	Suitable for applications acc.	IEC/UL 62368-1	Audio/video, information and communication technology equipment - Part 1: Safety requirements
	Suitable for applications acc.	IEC 60335-1	Safety of electrical appliances for household and similar purposes. Meets the requirements for appliances in unattended use. This includes the enhanced requirements of glow wire tests acc. to IEC 60695-2-11 or -12 & -13.

Compliances

The product complies with following Guide Lines

Identification	Details	Initiator	Description
	CE declaration of conformity	SCHURTER AG	The CE marking declares that the product complies with the applicable requirements laid down in the harmonisation of Community legislation on its affixing in accordance with EU Regulation 765/2008.
	UKCA declaration of conformity	SCHURTER AG	The UKCA marking declares that the product complies with the applicable requirements laid down in the British Amendment of Regulation (EC) 765/2008.
	RoHS	SCHURTER AG	Directive RoHS 2011/65/EU, Amendment (EU) 2015/863
	China RoHS	SCHURTER AG	The law SJ / T 11363-2006 (China RoHS) has been in force since 1 March 2007. It is similar to the EU directive RoHS.
	REACH	SCHURTER AG	On 1 June 2007, Regulation (EC) No 1907/2006 on the Registration, Evaluation, Authorization and Restriction of Chemicals 1 (abbreviated as "REACH") entered into force.
		SCHURTER AG	V-Lock system are based on a matching plug-dose combination. The connector is equipped with a notch intended for use with the latching cordset. The cord latching system prevents against accidental removal of the cordset.
	White Paper Glow wire test	SCHURTER AG	Meets the requirements of IEC 60335-1 for appliances in unattended use. This includes the enhanced requirements of glow wire tests acc. to IEC 60695-2-11 or -12 & -13.

Dimensions [mm]

Screw-on mounting

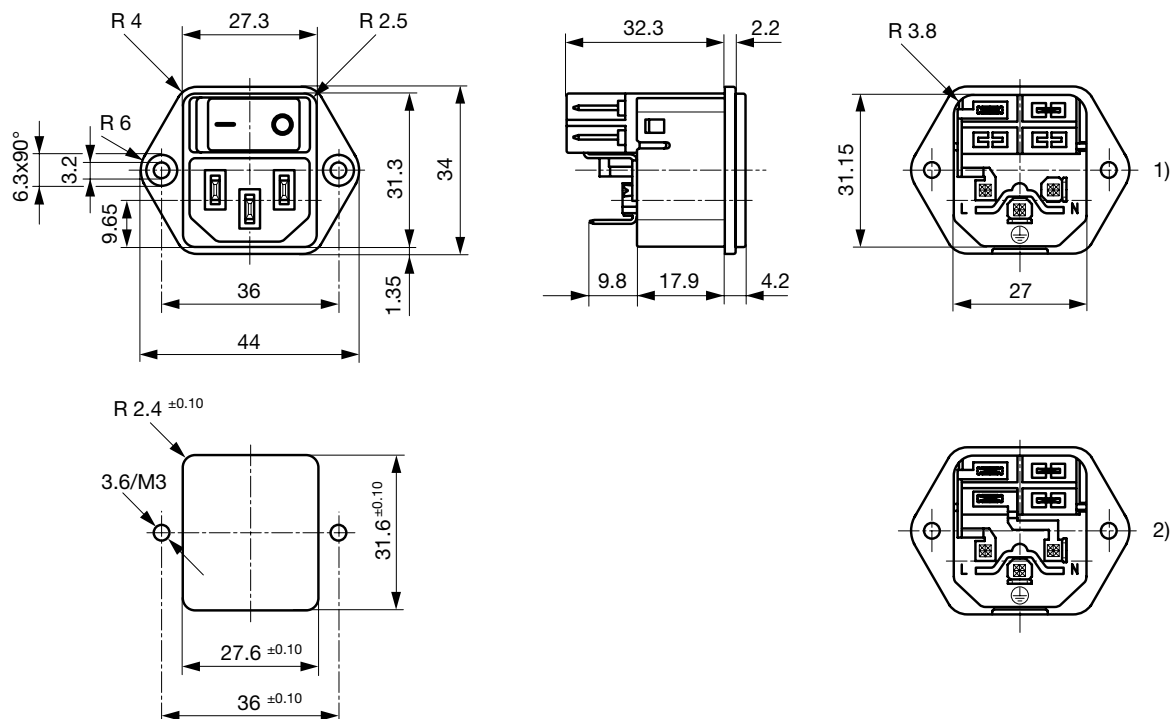

- 1) 1-pol non-illuminated
- 2) 2-pol illuminated, 2-pol non-illuminated

Snap-in mounting

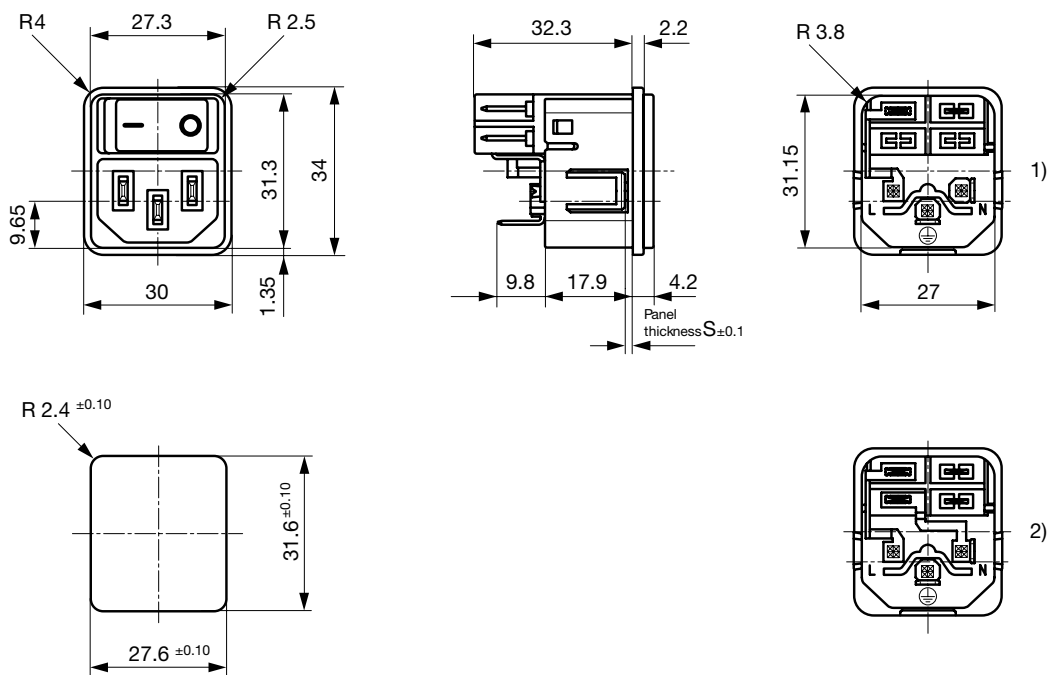

- 1) 1-pol non-illuminated
- 2) 2-pol illuminated, 2-pol non-illuminated

Diagrams

Line switch non-illuminated 2-pole

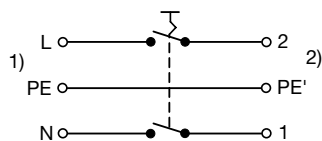

1) Line
2) Load

Line switch illuminated 2-pole

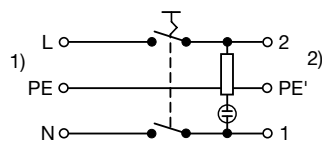

1) Line
2) Load

Line switch non-illuminated 1-pole

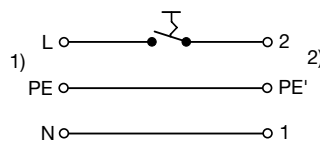

1) Line
2) Load

Variants

Rated Current UL [A]	Protection Class	Panel mounting	Panel Thickness s [mm]	Line Switch	Illumination	Color	Order Number
15	I	Snap-in	1.5	2-pole	●	red	DC11.0021.201
15	I	Snap-in	1.5	2-pole	●	red	DC11.0021.206
15	I	Snap-in	2	2-pole	●	red	DC11.0021.301
15	I	Snap-in	2.5	2-pole	●	red	DC11.0021.401
15	I	Snap-in	1.5	2-pole	●	green	DC11.0031.201
15	I	Snap-in	2	2-pole	●	green	DC11.0031.301
15	I	Snap-in	2.5	2-pole	●	green	DC11.0031.401
15	I	Snap-in	1.5	1-pole	-	-	DC11.0001.203
15	I	Snap-in	1.5	1-pole	-	-	DC11.0001.207
15	I	Snap-in	2	1-pole	-	-	DC11.0001.303
15	I	Snap-in	2.5	1-pole	-	-	DC11.0001.403
15	I	Snap-in	1.5	2-pole	-	-	DC11.0001.201
15	I	Snap-in	1.5	2-pole	-	-	DC11.0001.206
15	I	Snap-in	2	2-pole	-	-	DC11.0001.301
15	II	Snap-in	2	2-pole	-	-	DC11.0001.351
15	I	Snap-in	2.5	2-pole	-	-	3-107-445
15	I	Snap-in	2.5	2-pole	-	-	DC11.0001.401
15	I	Snap-in	3	2-pole	-	-	DC11.0001.501
15	I	Screw	-	2-pole	●	red	DC11.0021.001
15	I	Screw	-	2-pole	●	red	DC11.0021.006
15	I	Screw	-	2-pole	●	green	DC11.0031.001
15	I	Screw	-	1-pole	-	-	DC11.0001.003
15	I	Screw	-	1-pole	-	-	DC11.0001.007
15	I	Screw	-	2-pole	-	-	DC11.0001.001
15	I	Screw	-	2-pole	-	-	DC11.0001.006

Availability for all products can be searched real-time: <https://www.schurter.com/en/info-center/support-tools/stock-check-distributors>

With screw mounting on PCB, 2 screws are included

All variants according VDE (ENEC 10) approved for 10 A

Packaging unit

50 Pcs

Accessories

Description



[Wire_Harness](#)
 Wire harness for SCHURTER products



[RC320](#)
 Rear Cover for Power Entry Module



[Cord_retaining_kits](#)
 Cord retaining strain relief

Flat head, A	4700.0001
Countersunk, B	4700.0002

Mating Outlets/Connectors

Category / Description

[Appliance Outlet Overview complete](#)



4787, Mounting: Screw-on mounting, Appliance Outlet: IEC Solder terminals, 10 A, Suitable for appliances with protection class I	4787
4788, Mounting: Snap-in version, Appliance Outlet: IEC Solder / Quick Connect, 10 A, Suitable for appliances with protection class I	4788
IEC Appliance Outlet F or H, Screw-on Mounting, Front Side, Solder, PCB or Quick-connect Terminal	5091

[Connector Overview complete](#)



4782 Mounting: Power Cord, 3 x 1 mm ² / 3 x 18 AWG, Cable, Connector: IEC C13	4782
4785 Mounting: Power Cord, 3 x 1 mm ² / 3 x 18 AWG, Cable, Connector: IEC C13	4785
4300-06 Mounting: Power Cord, 3 x 1 mm ² / 3 x 18 AWG, Cable, Connector: IEC C13	4300-06
4781 Mounting: Power Cord, Cable, Connector: IEC C15	4781
4784 Mounting: Power Cord, 3 x 1 mm ² / 3 x 18 AWG, Cable, Connector: IEC C15	4784

[Power Supply Cord Overview complete](#)



Cord Sets 10 A, Europlug, 2.5 m, Connector IEC C13, H05VV-F3G1.0, black	6004.0215
Cord Sets 10 A, Europlug, 2.5 m, Connector IEC C13, H05VV-F3G1.0, black	6003.0215

Mating Outlets/Connectors shuttered



[Connector Overview complete](#)

4783 Mounting: Power Cord, 3 x 1 mm ² / 3 x 18 AWG, Cable, Connector: IEC C13	4783
--	------



[Power Cord Overview complete](#)

VAC13KS, Overview, V-Lock cord retaining, diverse Connector IEC C13, diverse, black	VAC13KS
VAC17KS, V-Lock cord retaining, diverse m, Connector IEC C17, diverse, black / grey / white	VAC17KS