

IEC Appliance Inlet C20 with Filter, Circuit Breaker TA45 (recessed)



Screw-on from front side
 Rocker non-illuminated
 white



Screw-on from front side
 Rocker illuminated
 orange



See below:
[Approvals and Compliances](#)

Description

- Panel mount :
 Screw-on mounting front side
- 3 Functions :
 Appliance Inlet Protection class I , circuit breaker type TA45 2-pole
 , Line filter in standard and medical version
- Quick connect terminals 6.3 x 0.8 mm

Characteristics

- All single elements are already wired
- Circuit Breaker non-illuminated or illuminated
- With EMC-shield
- For applications according IEC/UL 62368-1 we recommend variants with bleed resistor
 Suitable for use in medical equipment according to IEC/UL 60601-1 (1 MOOP, 1 MOPP)

Other versions on request

- Variant with notch for V-Lock mating Cordsets

References

- Alternative: version without line filter
- Alternative: Standard version

Weblinks

[pdf data sheet](#), [html datasheet](#), [General Product Information](#), [Approvals](#), [Distributor-Stock-Check](#), [Accessories](#), [Detailed request for product](#)

Technical Data

Ratings IEC	12 - 16A @ Ta 40 °C / 250VAC; 50Hz
Ratings UL/CSA	12 - 20A @ Ta 40 °C / 250VAC; 60Hz
Leakage Current	standard < 0.5mA (250 V / 60Hz) medical < 5 µA (250 V / 60 Hz)
Dielectric Strength	> 1.7kVDC between L-N > 2.7kVDC between L/N-PE Test voltage (2 sec)
Allowable Operation Temperature	-10°C to 55°C
Climatic Category	10/055/21 acc. to IEC 60068-1
IP-Protection	front side IP40 acc. to IEC 60529
Protection Class	Suitable for appliances with protection class I acc. to IEC 61140
Terminal	Quick connect terminals 6.3 x 0.8 mm
Panel Thickness S	Screw: max 8mm Mounting screw torque max 0.5Nm
Material	Thermoplastic, black, UL 94V-0

Appliance inlet/-outlet	C20 acc. to IEC 60320-1, UL 498, CSA C22.2 no. 42 (for cold conditions) pin-temperature 70 °C, 16A, Protection Class I
Circuit Breakers	Acc. IEC/EN 60934, UL 1077, CSA 22.2 no. 235 2-pole rocker switch, illuminated or non-illuminated. Optional with undervoltage release Short circuit capacity Icn: at In < 3A/240VAC : 10 x In at In ≥ 3A/240VAC : 300A
Line Filter	Standard and Medical Version, IEC 60939, UL 1283, CSA C22.2 no. 8 Technical Details
MTBF	> 100'000h acc. to MIL-HB-217 F

Approvals and Compliances



Detailed information on product approvals, code requirements, usage instructions and detailed test conditions can be looked up in [Details about Approvals](#)

SCHURTER products are designed for use in industrial environments. They have approvals from independent testing bodies according to national and international standards. Products with specific characteristics and requirements such as required in the automotive sector according to IATF 16949, medical technology according to ISO 13485 or in the aerospace industry can be offered exclusively with customer-specific, individual agreements by SCHURTER.

Approvals







The approval mark is used by the testing authorities to certify compliance with the safety requirements placed on electronic products.

Approval Reference Type: EF12

Approval Logo	Certificates	Certification Body	Description
	VDE Approvals	VDE	Certificate Number: 40001520
	UL Approvals	UL	UR File Number: E72928



Product standards

Product standards that are referenced

Organization	Design	Standard	Description
	Designed according to	IEC 60320-1	Appliance couplers for household and similar general purposes
	Designed according to	IEC 60939	Passive filters for suppressing electromagnetic interference
	Designed according to	IEC 61058-1	Switches for appliances. Part 1. General requirements
	Designed according to	UL 498	Standard for Attachment Plugs and Receptacles
	Designed according to	UL 1283	Passive filters for suppressing electromagnetic interference
	Designed according to	CSA C22.2 no. 42	General Use Receptacles, Attachment Plugs, and Similar Wiring Devices
	Designed according to	CSA C22.2 no. 8	Electromagnetic interference (EMI) filters







Application standards

Application standards where the product can be used

Organization	Design	Standard	Description
	Suitable for applications acc.	IEC/UL 62368-1	Audio/video, information and communication technology equipment - Part 1: Safety requirements
	Suitable for applications acc.	IEC 60601-1	Medical electrical equipment - Part 1: General requirements for basic safety and essential performance

Compliances

The product complies with following Guide Lines

Identification	Details	Initiator	Description
	CE declaration of conformity	SCHURTER AG	The CE marking declares that the product complies with the applicable requirements laid down in the harmonisation of Community legislation on its affixing in accordance with EU Regulation 765/2008.
	UKCA declaration of conformity	SCHURTER AG	The UKCA marking declares that the product complies with the applicable requirements laid down in the British Amendment of Regulation (EC) 765/2008.
	RoHS	SCHURTER AG	Directive RoHS 2011/65/EU, Amendment (EU) 2015/863
	China RoHS	SCHURTER AG	The law SJ / T 11363-2006 (China RoHS) has been in force since 1 March 2007. It is similar to the EU directive RoHS.
	REACH	SCHURTER AG	On 1 June 2007, Regulation (EC) No 1907/2006 on the Registration, Evaluation, Authorization and Restriction of Chemicals 1 (abbreviated as "REACH") entered into force.
		SCHURTER AG	V-Lock system are based on a matching plug-dose combination. The connector is equipped with a notch intended for use with the latching cordset. The cord latching system prevents against accidental removal of the cordset.
	Medical Equipment	SCHURTER AG	Suitable for use in medical equipment according to IEC/UL 60601-1 (1 MOOP, 1 MOPP)

Dimensions [mm]

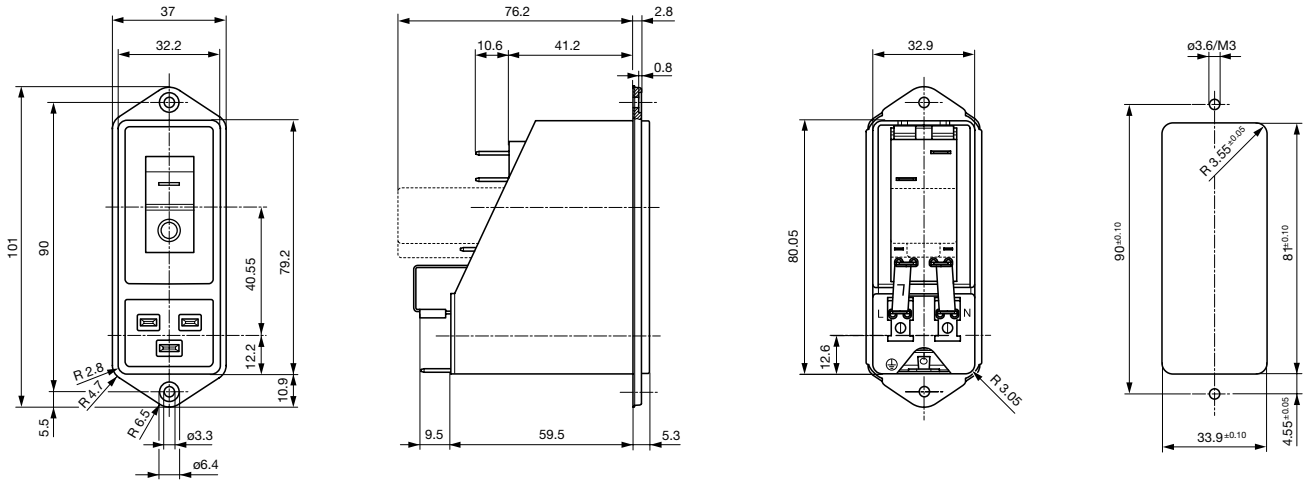

* --- Version TA45 with undervoltage release

Technical Data of Filter-Components

Rated Current [A]	Filter-Type	Inductances L [mH]	Capacitance CX [nF]	Capacitance CY [nF]	R [M Ω]
12	Standard version	2 x 0.8	100	2.2	1
16	Standard version	2 x 0.6	100	2.2	1
20	Standard version	2 x 0.3	100	2.2	1
12	Medical Version (M5)	2 x 0.8	100	-	1
16	Medical Version (M5)	2 x 0.6	100	-	1
20	Medical Version (M5)	2 x 0.3	100	-	1

Diagrams

Standard version

Medical Version (M5)

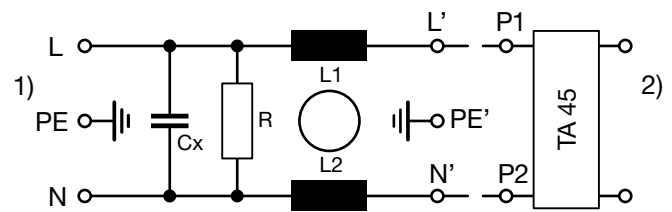
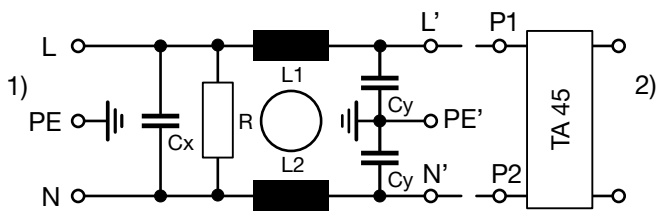

1) Line
2) Load

1) Line
2) Load

Attenuation Loss

--- 50Ω differential mode ____ 50Ω common mode

Standard version

12 A

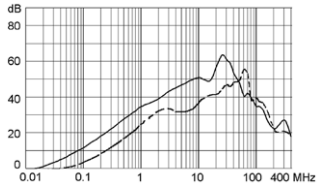

16 A

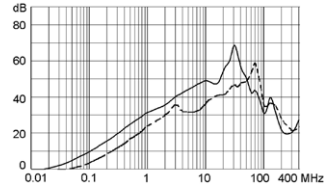

20 A

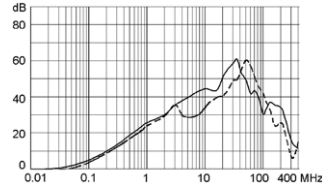

Medical version (M5)

12 A

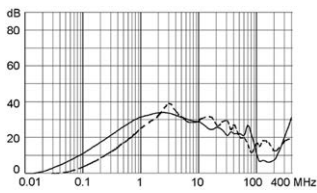

16 A

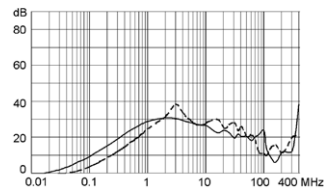

20 A

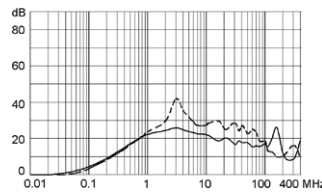

Effect of ambient temperature

The units are calibrated for an ambient temperature of +23°C. To determine the rated current for a lower or higher ambient temperature, use a correction factor (typical value) from the table below:

Ambient Temperature [°C]	Correction factor
-10	0.89
-5	0.91
0	0.92
+23	1.00
+30	1.03
+40	1.08
+55	1.16

Example: With a nominal current of 5A and an ambient temperature of 40°C, a correction factor of 1.08 results. This results in a nominal current of 5.5 A, which is rounded up to the next higher nominal current 6 A.

Time-Current-Curves

Tripping Characteristics $I_n < 3 A$

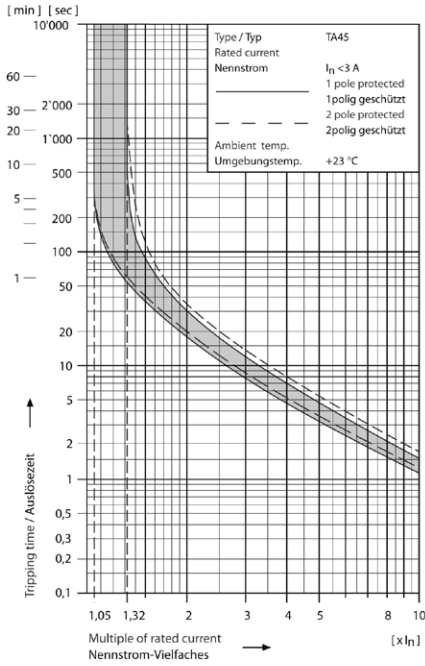

Tripping Characteristics $I_n \geq 3 \dots < 18 A$

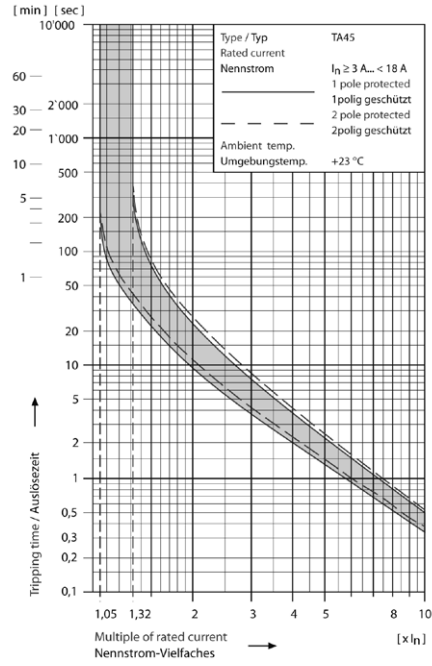

Tripping Characteristics $I_n \geq 18 A$

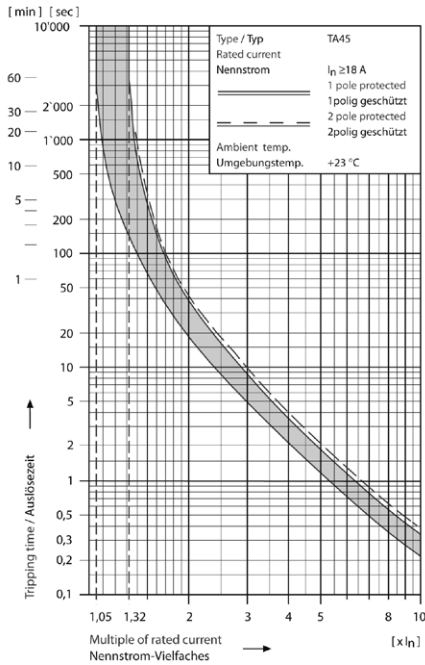

Order number key

Configurationcode TA45

Type	Configurationcode TA45															
EF12	A	B	T	W	F	1	5	0	C	0	-	000	-	111	-	000

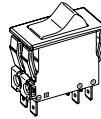

- Circuit Breaker of Equipment
- 2-pole, rocker actuated
- Quick connect terminal
- Other types on request

Without release: code C0

Undervoltage release

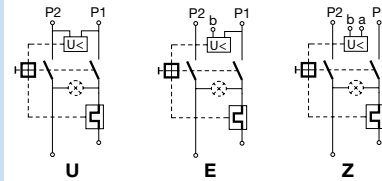

	Code	Rated voltage U_n
•	2	240 V AC
•	3	230 V AC
•	4	120 V AC

Rated current circuit breaker of equipment

I_n	Code	I_n	Code	I_n	Code	I_n	Code
10,0	100	13,0	130	16,0	160	19,0	190
11,0	110	14,0	140	17,0	170	20,0	200
12,0	120	15,0	150	18,0	180		

Other rated currents on request

Rocker legend

Surface	Illustration	Colour of print
F embossed	— ○	
H printed	ON OFF	white
K printed	ON OFF	black
L printed	— ○	white
M printed	— ○	black
P printed	I ○	white
R printed	I ○	black

Position of the rocker legend e.g F

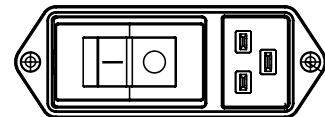

Colours

Switch front	Rocker
W black	white
B black	black
6 black	— orange transp.

Diagram

Thermal overload protection

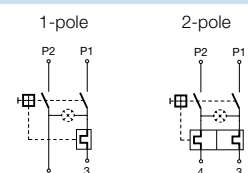

Without illumination

ABT **AED**

With illumination 220...240 V
 110...120 V

A12 **A32**
A14 **A34**

Configuration code (Order example)

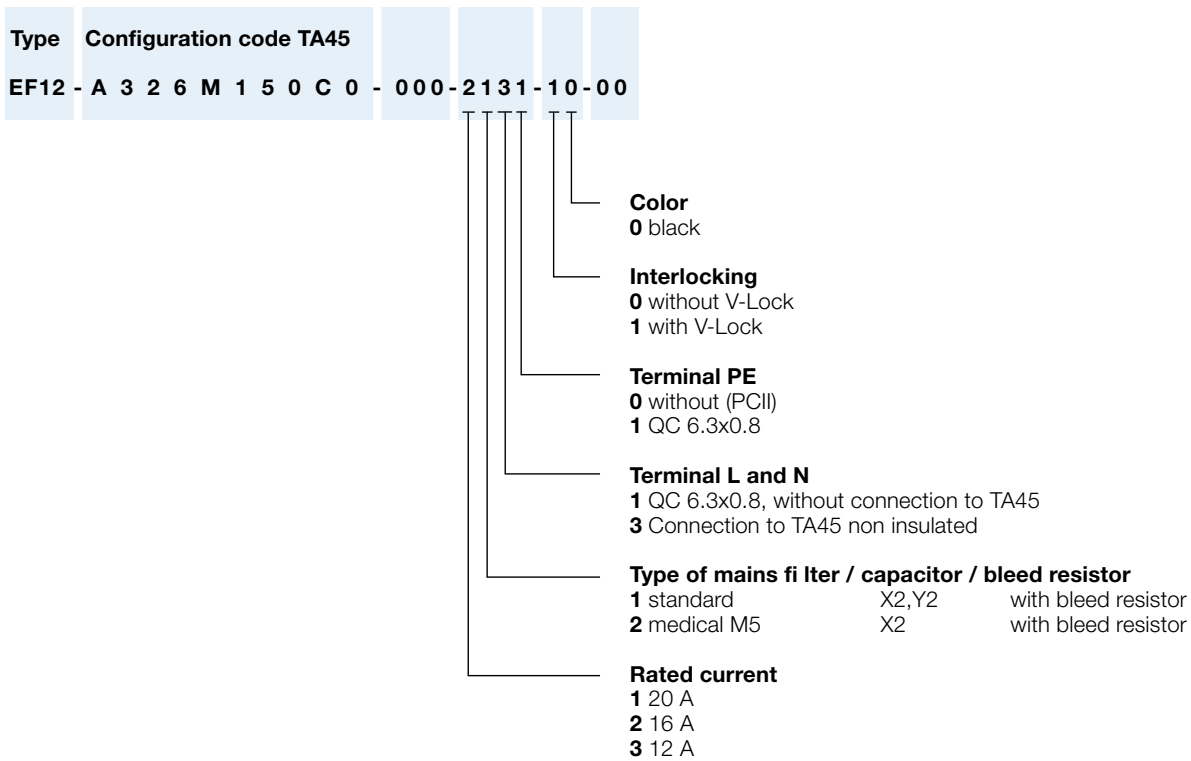

The rated current of the mains filter must not be less than the tripping current of the circuit breaker for equipment. Only the rated filter current is shown in the item description on the packaging.

Variants

Circuit Breakers				Filter		Connectors		Internally wired	Config. Code	Order Number
Rated Current [A]	Rocker colour	Illumination	Add-on modules	Rated Current [A]	Filter Type	Protection Class	V-Lock			
12	black	non-illuminated	-	12	Standard version	I		prewired	EF12-ABD-WF120C0-000-3131-00-00	EF12.1034.3110.01
15	black	non-illuminated	-	16	Standard version	I		prewired	EF12-ABD-WF150C0-000-2131-00-00	EF12.0885.2110.01
15	black	non-illuminated	-	20	Standard version	I		prewired	EF12-ABD-BL150C0-000-1131-00-00	EF12.1089.1110.01
16	black	non-illuminated	-	16	Standard version	I		prewired	EF12-ABT-WF160C0-000-2131-00-00	EF12.0034.2110.01
16	black	non-illuminated	-	16	Standard version	I		prewired	EF12-ABD-WF160C0-000-2131-00-00	EF12.0699.2110.01
16	black	non-illuminated	-	16	Standard version	I		prewired	EF12-ABD-BL160C0-000-2131-00-00	EF12.2105.2110.01
16	black	non-illuminated	-	16	Standard version	I		prewired	EF12-ABT-BP160C0-000-2131-00-00	EF12.3103.2110.01
20	black	non-illuminated	-	20	Standard version	I		prewired	EF12-ABT-WF200C0-000-1131-00-00	EF12.0035.1110.01
20	black	non-illuminated	-	20	Standard version	I		prewired	EF12-ABD-WF200C0-000-1131-00-00	EF12.0572.1110.01
20	black	non-illuminated	-	20	Standard version	I		prewired	EF12-ABT-WF200U2-000-1131-00-00	EF12.1164.1110.01
20	black	non-illuminated	-	20	Standard version	I		prewired	EF12-ABD-BL200C0-000-1131-00-00	EF12.2196.1110.01
20	black	non-illuminated	-	20	Standard version	I		prewired	EF12-A326K200C0-000-1131-00-00	EF12.2561.1110.01
20	black	non-illuminated	-	20	Standard version	I		prewired	EF12-ABD-WM200C0-000-1131-00-00	EF12.2961.1110.01

Circuit Breakers				Filter		Connectors		Internally wired	Config. Code	Order Number
Rated Current [A]	Rocker colour	Illumination	Add-on modules	Rated Current [A]	Filter Type	Protection Class	V-Lock			
20	black	non-illuminated	-	20	Standard version	I		prewired	EF12-A126K200C0-000-1131-00-00	EF12.3197.1110.01
16	black	non-illuminated	-	16	Medical Version (M5)	I		prewired	EF12-ABD-WF160C0-000-2231-00-00	EF12.0699.2210.01
20	black	non-illuminated	-	20	Medical Version (M5)	I		prewired	EF12-ABT-WF200C0-000-1231-00-00	EF12.0035.1210.01

Availability for all products can be searched real-time: <https://www.schurter.com/en/info-center/support-tools/stock-check-distributors>

Packaging unit 16 Pcs

Accessories

Description



[Cord_retaining_kits](#)
 Cord retaining strain relief

Flat head, H 4700.0008

Mating Outlets/Connectors

Category / Description



[Connector Overview complete](#)

4795, Mounting: Power Cord, Cable Connector: IEC C19 4795
 4790, Mounting: Power Cord, Screw Connector: IEC C19 4790

Mating Outlets/Connectors shuttered



[Power Cord Overview complete](#)

VAC19KS, Overview, V-Lock cord retaining, diverse Connector IEC C19, diverse, black VAC19KS