

Pyro Fuse



1000VDC

See below:  
[Approvals and Compliances](#)

**Description**

- Safety device to be triggered by ECU/BMS
- To break down the main circuit via trigger device actively
- To disconnect the battery circuit in abnormal conditions such as short circuits or collisions

**Unique Selling Proposition**

- High safety and reliability
- Mechanical vibration and shock resistance

**Applications**

- Electric Vehicles (EVs)
- Conventional Vehicle Electrical Systems
- Charging Infrastructure
- Photovoltaic (PV) & Energy Storage Systems (ESS)
- Household Energy
- Storage Electric Vessels
- Fuel Cell Technologies
- Aerospace (including eVTOL)

**Weblinks**

[pdf data sheet](#), [html datasheet](#), [General Product Information](#), [Distributor-Stock-Check](#), [Detailed request for product](#)

**Technical Data**





Rated Voltage	1000VDC
Rated current	400A
Breaking Capacity	1000 VDC/16 kA/20 μH
Internal Resistance (@20 °C)	≤50 μΩ (before breaking) ≥10 MΩ (after disconnection)
Ignition resistance	≥1.7 Ω, ≤2.5 Ω
Trigger Current	≥1.75 A /0.5 ms or ≥1.2 A/2 ms
No Trigger Current	≤0.4 A /≤ 10 s or ≤5 A /≤0.5 μs
Monitoring Current	< 100 mA
Mounting	Bolt-on A
Admissible Ambient Temp.	-40 °C to 105 °C
Material: Housing	PA6
Material: Terminals	Copper alloy, tin-plated
Unit Weight	< 300 g
Storage Conditions	-40 °C to 65 °C max. 70% r.h. @ 40 °C max. 80% r.h. @ 30 °C max. 90% r.h. @ 20 °C
Product Marking	 Type Description, Type, Rated current, Rated Voltage

Resistance to Vibration	LV 124-2
Current Carrying Capacity	400 A Continuous current @ 85 °C (Busbar size ≥120 mm²)
Action Time	<2 ms
Mechanical Shock	LV 124-2
Temperature Cycling	LV 124-2
Chemical resistance	LV 124-2
Installation	M8 screw (Copper busbar) ISO 19072 AKII (trigger)

**Approvals and Compliances**

**Compliances**

The product complies with following Guide Lines

Identification	Details	Initiator	Description
	<a href="#">CE declaration of conformity</a>	SCHURTER AG	The CE marking declares that the product complies with the applicable requirements laid down in the harmonisation of Community legislation on its affixing in accordance with EU Regulation 765/2008.
	<a href="#">RoHS</a>	SCHURTER AG	Directive RoHS 2011/65/EU, Amendment (EU) 2015/863
	<a href="#">China RoHS</a>	SCHURTER AG	The law SJ / T 11363-2006 (China RoHS) has been in force since 1 March 2007. It is similar to the EU directive RoHS.
	<a href="#">REACH</a>	SCHURTER AG	On 1 June 2007, Regulation (EC) No 1907/2006 on the Registration, Evaluation, Authorization and Restriction of Chemicals 1 (abbreviated as "REACH") entered into force.

Dimension [mm] 

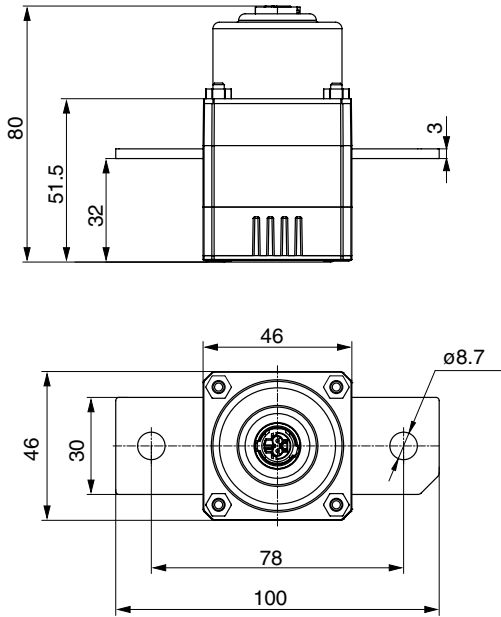

**Electric separation time**

Time summand	Typical	Maximum
Ignition delay	0.3 ms @1.75 A	0.5 ms @1.75 A
Mechanical separation time	0.2 ms	0.5 ms
Breaking time	0.5 ms	1.0 ms
Total switching time	1.0 ms	2.0 ms

Breaking Behavior

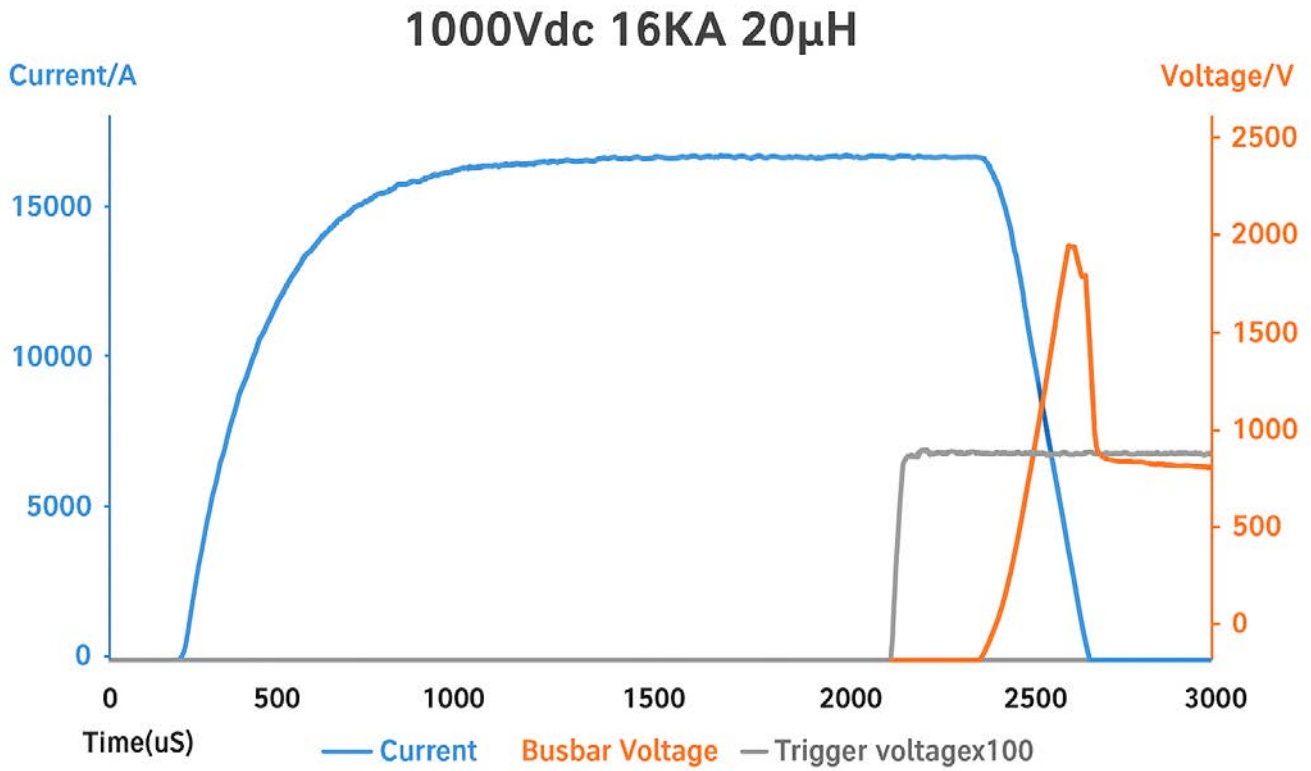

Variants

Rated current [A]	Rated Voltage [VDC]	Breaking Capacity	Connector Type	Order Number
400	1000	1000 VDC/16 kA/20 μH	AK-2 Code I	3-158-119

Availability for all products can be searched real-time: <https://www.schurter.com/en/info-center/support-tools/stock-check-distributors>

Packaging Unit

Bulk 445 x 370 x 268 mm (18 pcs.)

**Hazardous Materials Safety Instructions****Short-Circuit Ring**

The connector has a shorting clip. If not fully inserted, it shorts the two pins to prevent accidental activation during transport, installation, or use.

**Ground Isolation**

The low-voltage trigger signal must be isolated from the high-voltage system ground. A common ground or connection is prohibited.

**Breaking Capacity**

Do not use the fuse if the fault current exceeds its rated breaking capacity. Contact Schurter for applications with higher currents.

**Dropped Units**

Do not use a product that has been dropped. It must be inspected before any further use.

**Physical Damage**

Do not use a unit with any damage to the body or components.

**Triggering Power Source**

Only use designated triggering equipment. Do not use lead-acid or dry-cell batteries.

**RISK OF MATERIAL DAMAGE AND HOT ENCLOSURE**

- The product's side panels can become hot during operation. Allow the unit to cool completely before touching.
- Follow the mounting instructions carefully, ensuring all fastenings are tightened to the specified torque values.
- Do not allow liquids or foreign objects to enter the product.

Not following these instructions can cause serious injury or damage to equipment.

**HAZARD OF ELECTRIC SHOCK, EXPLOSION OR ARC FLASH**

- Disconnect all power before installing or working with this equipment
- Verify all connections and replace all covers before turning on power Failure to follow these instructions will result in death or severe injury.



Transportation Hazard Classification: UN3268, Class 9